

# Data Sheet

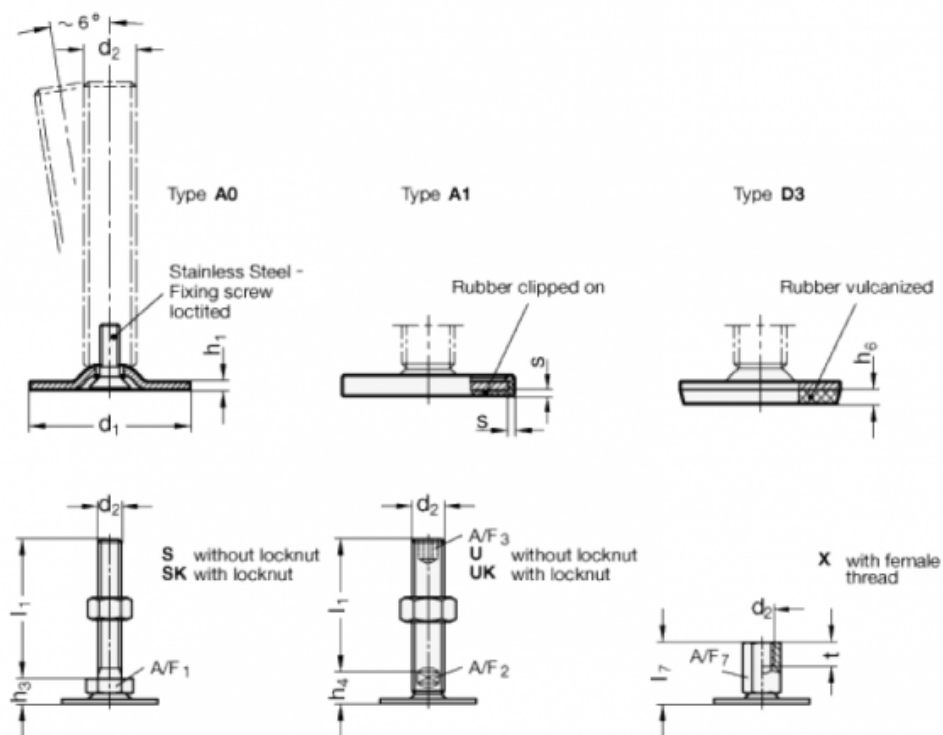

Article number: 204080M1050A0SK  
 Description: E+G levelling foot  
 GN 40-80-M10-50-A0-SK  
 Note: SK With nut, External hexagon at the bottom

## Measures



A/F1 = 17  
 d1 = 80  
 d2 = M10  
 h1 = 3  
 h3 = 12  
 h6 =  
 l1 = 50  
 s =